

LH0076 Negative Precision Programmable Regulator

General Description

The LH0076 is a precision programmable regulator for negative voltages. Regulated output voltages from 0 to $-27V$ may be obtained by using 1 external resistor. Also available without any external components are several fixed regulated voltages with accuracies to 0.1% ($-3V$, $-5V$, $-6V$, $-8V$, $-9V$, $-12V$, $-15V$ and $-18V$). The output current limit is adjustable from 0 to 200 mA using 2 external resistors. These features provide an inventory of precision regulated values in 1 package.

Features

- Line regulation typically 0.005%/V
- Load regulation typically 0.02%
- Remote voltage sensing
- Ripple rejection—70 dB
- Output Adjustable to 0V
- Adjustable precision current limit
- Output current to 200 mA

Schematic Diagram

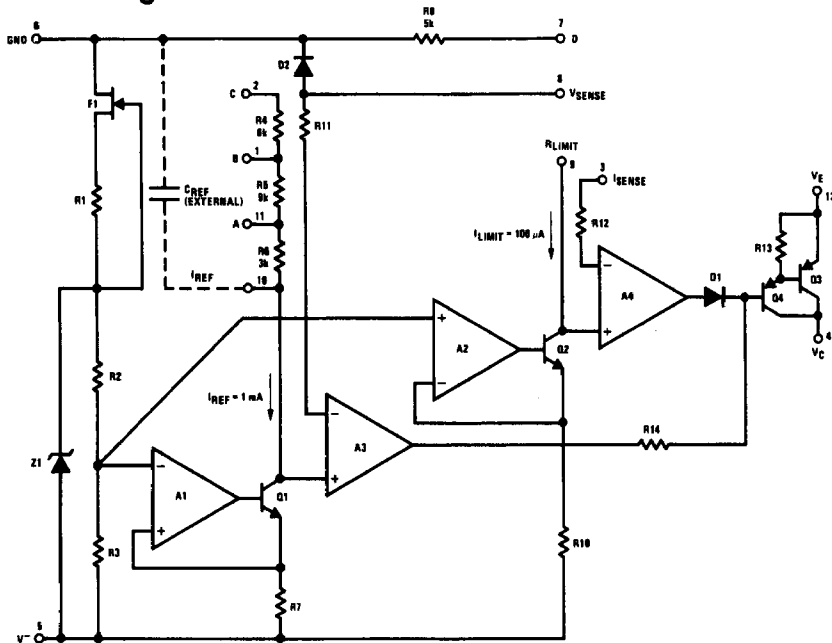

Connection Diagram

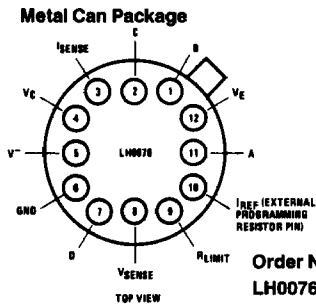

Typical Applications

Precision $-15V$ Reference Supply without Current Limit

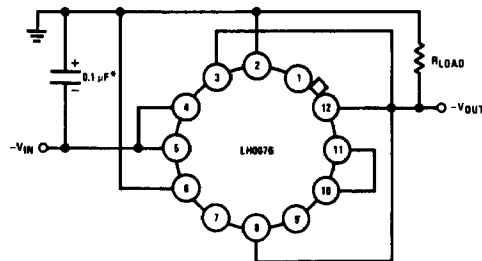

*Recommended if device is far from filter capacitors

TL/H/5548-1

1

Order Number

LH0076G

LH0076CG

See NS Package H12B

Absolute Maximum Ratings

If Military/Aerospace specified devices are required, please contact the National Semiconductor Sales Office/Distributors for availability and specifications. (Note 4)

Input Voltage	-32V
Output Voltage	-27V
Output Current	200 mA
Power Dissipation	See Curve

Operating Temperature Range

LH0076	-55°C to +125°C
LH0076C	-25°C to +85°C

Storage Temperature

-65°C to +150°C

Lead Temperature

(Soldering, 10 seconds) 300°C

Electrical Characteristics

Conditions are for $T_{MIN} \leq T_A \leq T_{MAX}$ unless otherwise noted

Parameter	Conditions	LH0076			LH0076C			Units
		Min	Typ	Max	Min	Typ	Max	
Line Regulation	$T_A = 25^\circ\text{C}$		0.005	0.02		0.005	0.04	%/V
Load Regulation	$T_A = 25^\circ\text{C}$, $1\text{ mA} < I_{LOAD} < 200\text{ mA}$ $V_{OUT} \geq -5.0\text{V}$ $V_{OUT} \leq -5.0\text{V}$			7.5			15	mV
			0.02	0.15		0.02	0.3	%
Reference Current (I_{REF})	$T_A = 25^\circ\text{C}$, $V_{IN} = -15\text{V}$	0.998	1.000	1.002	0.995	1.000	1.005	mA
Reference Current Drift ($\Delta I_{REF}/\Delta\text{Temp.}$)	$V_{IN} = -15\text{V}$		-0.0065			-0.0065		%/°C
Minimum Load Current (I_{LIM})	(Note 1)	98	100	102	95	100	105	μA
Output Voltage Range		0		-27	0		-27	V
Minimum Input Voltage		-10			-10			V
Input-Output Differential Voltage	$T_A = 25^\circ\text{C}$, $1\text{ mA} < I_{LOAD} < 200\text{ mA}$		2.7	3.2		2.7	3.5	V
Quiescent Supply Current	$V_{IN} = -15\text{V}$		11	15		11	15	mA
Ripple Rejection	$V_{OUT} = 5.0\text{V}$, $f = 120\text{ Hz}$		70			70		dB
Output Voltage Tolerance	$T_A = 25^\circ\text{C}$, (Note 2)		± 0.1	± 0.5		± 0.1	± 1.0	%
Output Voltage Change with Temperature ($\Delta V_{OUT}/\Delta\text{Temp.}$)	(Note 3)		0.003			0.003		%/°C

Note 1: Minimum load current is established by I_{LIM} , the current to Q2 (see schematic.) I_{LIM} draws directly from the output if the current limit feature is used.

Note 2: For $V_{IN} = 15\text{V}$ and V_{OUT} obtained by using R4, R5, R6, and R8 individually.

Note 3: Total change over specified temperature range.

Note 4: Refer to RETS0076G for military specifications on the LH0076.

Typical Performance Characteristics

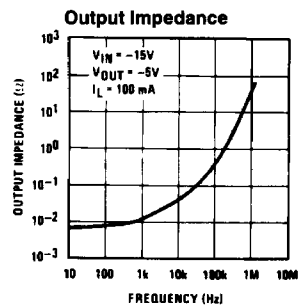
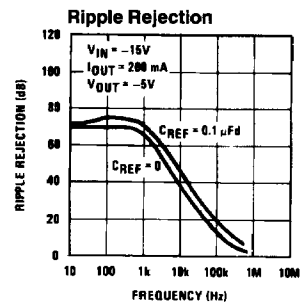
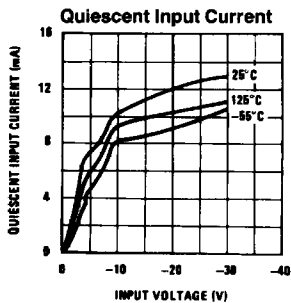
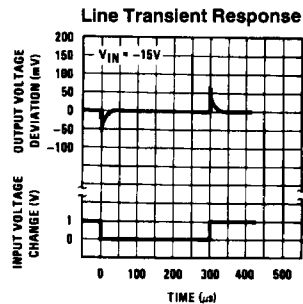
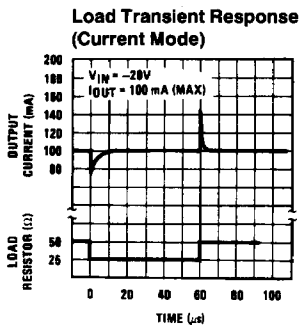
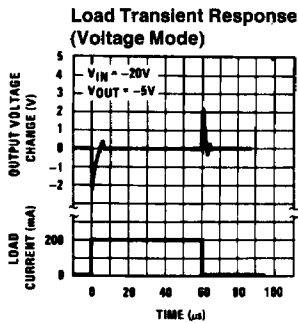
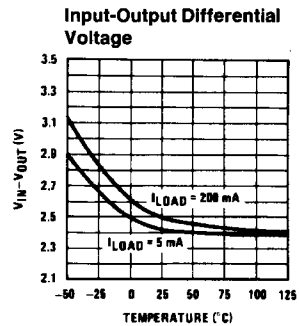
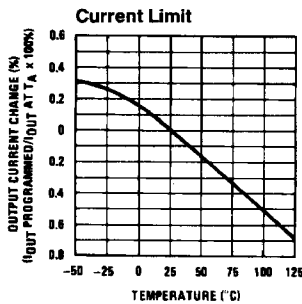
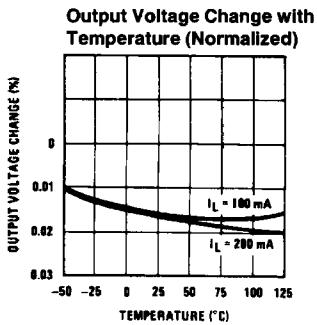
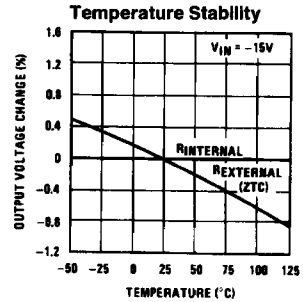
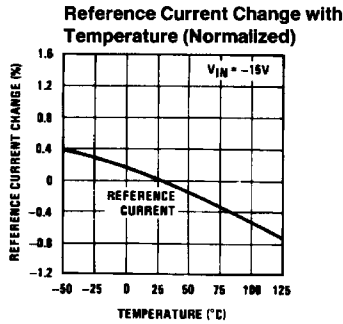
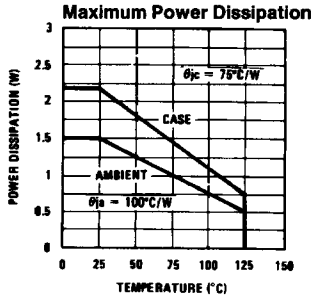

Typical Applications (Continued)

Variable Voltage Reference with Current Limit

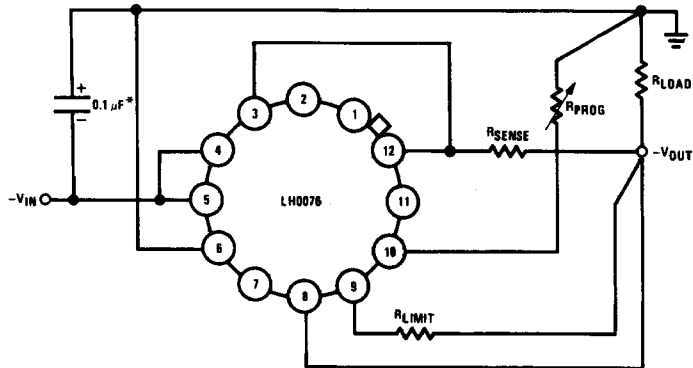

2-Amp Regulator with Current Limit

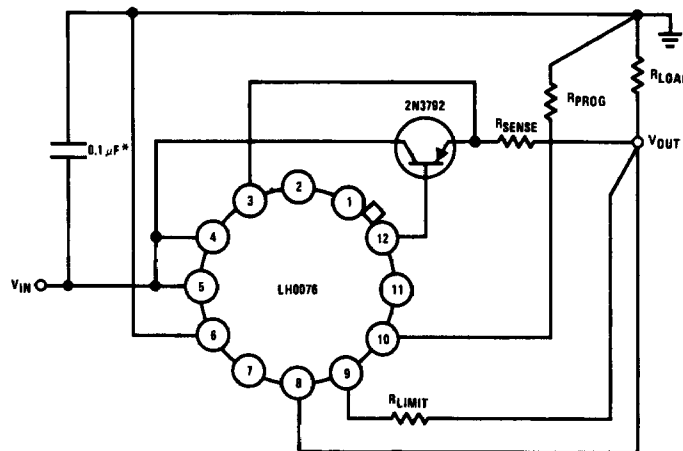

*Recommended if device is far from filter capacitors

TL/H/5548-4

Application Information

The LH0076 does not require external capacitors for stable operation. However, an input bypass is recommended if the device is far from filter capacitors. A 0.1 μ F for input bypassing should be adequate for most applications.

DESCRIPTION OF OPTIONS

External Voltage Programming

An external resistance can be connected between pin 10 and ground to obtain any voltage from 0 to -27 V using the following equation:

$$R_{EXT} = \frac{V_{OUT \text{ desired}}}{-1 \text{ mA}}$$

The reference current (I_{REF}) has a typical temperature coefficient of -60 ppm/ $^{\circ}$ C. Choosing a resistive material with a temperature coefficient of 60 ppm/ $^{\circ}$ C will compensate the negative tempco of the reference current, resulting in an output voltage with minimal change over the operating temperature range. Example of a good resistive material is nichrome, which has a typical tempco of 80 ppm/ $^{\circ}$ C. Nichrome is the resistive material used in the LH0076, resulting in output voltage drift of 20 ppm/ $^{\circ}$ C typically.

Application Information (Continued)

Because a current source is used as a reference, remote voltage programming is possible.

Internal Voltage Programming

The LH0076 provides various precision output voltages simply by using 1 or more of the internal programming resistors. These voltages may be obtained by using the connections as shown in Table 1.

R_{TOTAL} is the total resistance between pin 10 and ground

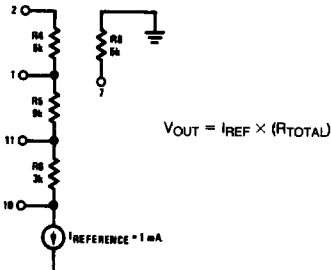

R4, R5, R6 and R8 are precision trimmed to 0.1%

FIGURE 1

Current Limit Programming

The maximum current output of the device may be limited by adding 2 external resistors as shown in Figure 2. The resistor values are calculated using the following equation:

$$I_{OUT(MAX)} = \left[\frac{R_{LIMIT}}{R_{SENSE}} + 1 \right] \times 100\mu A$$

where $R_{SENSE} = 1$ to 10Ω

This programming current limit feature can be extended to make the LH0076 a programmable current sink. This can be done by leaving pin 10 open and setting R_{LIMIT} and R_{SENSE} as desired. (See Figure 3).

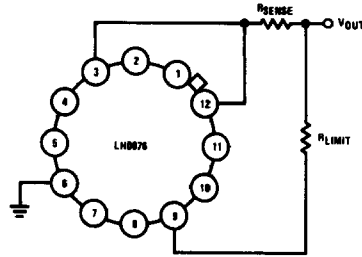

TL/H/5548-6

FIGURE 2. Current Limit Programming

For application where the current limit is used, a minimum load current of $100\mu A$ is established at the output. This arises from the fact that the constant current used in setting maximum output current is $100\mu A$, and it comes directly from the output of the LH0076. If the total current is less than this minimum current, the output will drop.

As in the remote voltage adjustment application, remote current sensing can be applied similarly. R_{SENSE} should be placed as close to the output of the LH0076 as possible, but R_{LIMIT} can be a resistor or potentiometer located remotely from the device.

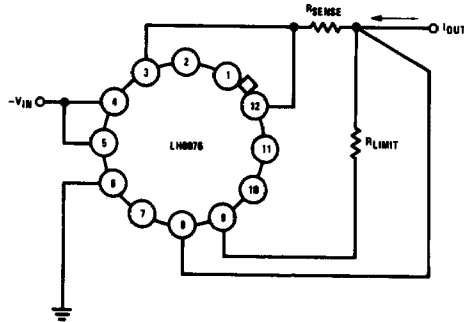

TL/H/5548-7

FIGURE 3. Precision Current Sink

TABLE 1. Connection Scheme for Internally Available Output Voltages

OUTPUT VOLTAGE (V)	PIN 1	PIN 2	PIN 7	PIN 10	PIN 11
-3					GND
-5			—————		
-6	—————	Gnd	—————		
-8			—————		
-9	Gnd			—————	
-12	Gnd				
-15				—————	
-18		Gnd			