

ARCHIVED BY FREESCALE SEMICONDUCTOR, INC. 2005

# Micromachined Accelerometer

The MMA series of silicon capacitive, micromachined accelerometers features signal conditioning, a 4-pole low pass filter and temperature compensation. Zero-g offset full scale span and filter cut-off are factory set and require no external devices. A full system self-test capability verifies system functionality.

### Features

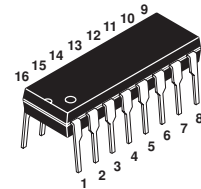
- Integral Signal Conditioning
- Linear Output
- Ratiometric Performance
- 4th Order Bessel Filter Preserves Pulse Shape Integrity
- Calibrated Self-test
- Low Voltage Detect, Clock Monitor, and EPROM Parity Check Status
- Transducer Hermetically Sealed at Wafer Level for Superior Reliability
- Robust Design, High Shocks Survivability
- Two Packaging Options Available:
  - 1) Plastic DIP for Z Axis Sensing (MMA1201P)
  - 2) Wingback for X Axis Sensing (MMA2200W)

### Typical Applications

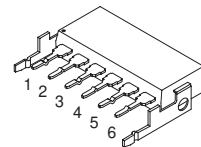
- Vibration Monitoring and Recording
- Appliance Control
- Mechanical Bearing Monitoring
- Computer Hard Drive Protection
- Computer Mouse and Joysticks
- Virtual Reality Input Devices
- Sports Diagnostic Devices and Systems

**MMA1201P**  
**MMA2200W**

**MMA1201P: Z AXIS SENSITIVITY**  
**MMA2200W: X AXIS SENSITIVITY**  
**MICROMACHINED**  
**ACCELEROMETER**  
 $\pm 40g$

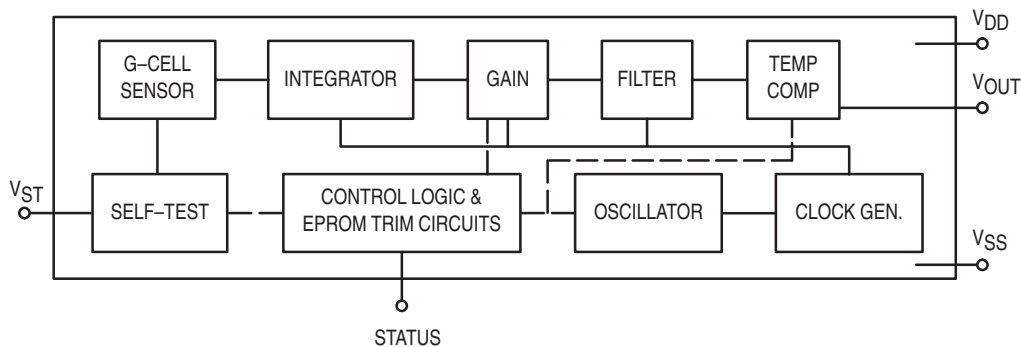


**DIP PACKAGE**  
 CASE 648C-04  
 MMA1201P



**WB PACKAGE**  
 CASE 456-06  
 MMA2200W

**SIMPLIFIED ACCELEROMETER FUNCTIONAL BLOCK DIAGRAM**



**Figure 1. Simplified Accelerometer Functional Block Diagram**

REV 0



MAXIMUM RATINGS (Maximum ratings are the limits to which the device can be exposed without causing permanent damage.)

Rating	Symbol	Value	Unit
Powered Acceleration (all axes)	$G_{pd}$	500	g
Unpowered Acceleration (all axes)	$G_{upd}$	2000	g
Supply Voltage	$V_{DD}$	-0.3 to +7.0	V
Drop Test <sup>(1)</sup>	$D_{drop}$	1.2	m
Storage Temperature Range	$T_{stg}$	-40 to +105	°C

NOTES:

1. Dropped onto concrete surface from any axis.

**ELECTRO STATIC DISCHARGE (ESD)**

**WARNING: This device is sensitive to electrostatic discharge.**

Although the Motorola accelerometers contain internal 2kV ESD protection circuitry, extra precaution must be taken by the user to protect the chip from ESD. A charge of over

2000 volts can accumulate on the human body or associated test equipment. A charge of this magnitude can alter the performance or cause failure of the chip. When handling the accelerometer, proper ESD precautions should be followed to avoid exposing the device to discharges which may be detrimental to its performance.

Freescale Semiconductor, Inc.

ARCHIVED BY FREESCALE SEMICONDUCTOR, INC. 2005

**OPERATING CHARACTERISTICS**

(Unless otherwise noted:  $0^{\circ}\text{C} \leq T_A \leq +85^{\circ}\text{C}$ ,  $4.75 \leq V_{DD} \leq 5.25$ , Acceleration = 0g, Loaded output<sup>(1)</sup>)

Characteristic	Symbol	Min	Typ	Max	Unit
Operating Range <sup>(2)</sup>					
Supply Voltage <sup>(3)</sup>	$V_{DD}$	4.75	5.00	5.25	V
Supply Current	$I_{DD}$	4.0	5.0	6.0	mA
Operating Temperature Range	$T_A$	-40	—	+85	$^{\circ}\text{C}$
Acceleration Range	gFS	—	38	—	g
Output Signal					
Zero g ( $V_{DD} = 5.0\text{ V}$ ) <sup>(4)</sup>	$V_{OFF}$	2.2	2.5	2.8	V
Zero g	$V_{OFF,V}$	$0.44 V_{DD}$	$0.50 V_{DD}$	$0.56 V_{DD}$	V
Sensitivity ( $T_A = 25^{\circ}\text{C}$ , $V_{DD} = 5.0\text{ V}$ ) <sup>(5)</sup>	S	47.5	50	52.5	mV/g
Sensitivity ( $V_{DD} = 5.0\text{ V}$ )	$S_V$	9.3	10	10.7	mV/g/V
Bandwidth Response	$f_{-3dB}$	360	400	440	Hz
Nonlinearity	NL <sub>OUT</sub>	-1.0	—	+1.0	% FSO
Noise					
RMS (.01–1 kHz)	$n_{RMS}$	—	—	3.5	mVrms
Power Spectral Density	$n_{PSD}$	—	110	—	$\mu\text{V}/(\text{Hz}^{1/2})$
Clock Noise (without RC load on output) <sup>(6)</sup>	$n_{CLK}$	—	2.0	—	mVpk
Self-Test					
Output Response	gST	20	—	30	g
Input Low	$V_{IL}$	$V_{SS}$	—	$0.3 \times V_{DD}$	V
Input High	$V_{IH}$	$0.7 \times V_{DD}$	—	$V_{DD}$	V
Input Loading <sup>(7)</sup>	$I_{IN}$	-30	-110	-300	$\mu\text{A}$
Response Time <sup>(8)</sup>	t <sub>ST</sub>	—	2.0	10	ms
Status <sup>(12)(13)</sup>					
Output Low ( $I_{load} = 100\ \mu\text{A}$ )	$V_{OL}$	—	—	0.4	V
Output High ( $I_{load} = 100\ \mu\text{A}$ )	$V_{OH}$	$V_{DD} - .8$	—	—	V
Minimum Supply Voltage (LVD Trip)	$V_{LVD}$	2.7	3.25	4.0	V
Clock Monitor Fail Detection Frequency	$f_{min}$	50	—	260	kHz
Output Stage Performance					
Electrical Saturation Recovery Time <sup>(9)</sup>	t <sub>DELAY</sub>	—	0.2	—	ms
Full Scale Output Range ( $I_{OUT} = 200\ \mu\text{A}$ )	$V_{FSO}$	0.3	—	$V_{DD} - 0.3$	V
Capacitive Load Drive <sup>(10)</sup>	$C_L$	—	—	100	pF
Output Impedance	$Z_O$	—	300	—	$\Omega$
Mechanical Characteristics					
Transverse Sensitivity <sup>(11)</sup>	$V_{ZX,YX}$	—	—	5.0	% FSO
Package Resonance	f <sub>PKG</sub>	—	10	—	kHz

NOTES:

- For a loaded output the measurements are observed after an RC filter consisting of a 1 k $\Omega$  resistor and a 0.01  $\mu\text{F}$  capacitor to ground.
- These limits define the range of operation for which the part will meet specification.
- Within the supply range of 4.75 and 5.25 volts, the device operates as a fully calibrated linear accelerometer. Beyond these supply limits the device may operate as a linear device but is not guaranteed to be in calibration.
- The device can measure both + and - acceleration. With no input acceleration the output is at midsupply. For positive acceleration the output will increase above  $V_{DD}/2$  and for negative acceleration the output will decrease below  $V_{DD}/2$ .
- The device is calibrated at 20g.
- At clock frequency  $\cong 70\text{ kHz}$ .
- The digital input pin has an internal pull-down current source to prevent inadvertent self test initiation due to external board level leakages.
- Time for the output to reach 90% of its final value after a self-test is initiated.
- Time for amplifiers to recover after an acceleration signal causing them to saturate.
- Preserves phase margin (60 $^{\circ}$ ) to guarantee output amplifier stability.
- A measure of the device's ability to reject an acceleration applied 90 $^{\circ}$  from the true axis of sensitivity.
- The Status pin output is not valid following power-up until at least one rising edge has been applied to the self-test pin. The Status pin is high whenever the self-test input is high.
- The Status pin output latches high if a Low Voltage Detection or Clock Frequency failure occurs, or the EPROM parity changes to odd. The Status pin can be reset by a rising edge on self-test, unless a fault condition continues to exist.

**PRINCIPLE OF OPERATION**

The Motorola accelerometer is a surface-micromachined integrated-circuit accelerometer.

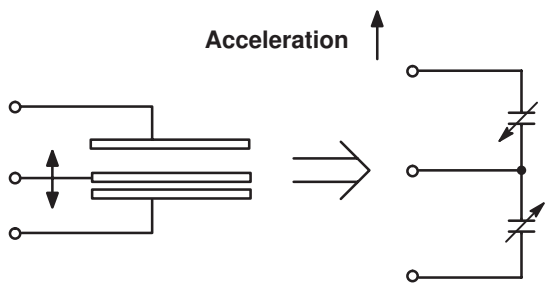
The device consists of a surface micromachined capacitive sensing cell (g-cell) and a CMOS signal conditioning ASIC contained in a single integrated circuit package. The sensing element is sealed hermetically at the wafer level using a bulk micromachined “cap” wafer.

The g-cell is a mechanical structure formed from semiconductor materials (polysilicon) using semiconductor processes (masking and etching). It can be modeled as two stationary plates with a moveable plate in-between. The center plate can be deflected from its rest position by subjecting the system to an acceleration (Figure 2).

When the center plate deflects, the distance from it to one fixed plate will increase by the same amount that the distance to the other plate decreases. The change in distance is a measure of acceleration.

The g-cell plates form two back-to-back capacitors (Figure 3). As the center plate moves with acceleration, the distance between the plates changes and each capacitor’s value will change, ( $C = A\epsilon/D$ ). Where A is the area of the plate,  $\epsilon$  is the dielectric constant, and D is the distance between the plates.

The CMOS ASIC uses switched capacitor techniques to measure the g-cell capacitors and extract the acceleration data from the difference between the two capacitors. The ASIC also signal conditions and filters (switched capacitor) the signal, providing a high level output voltage that is ratiometric and proportional to acceleration.



**Figure 2. Transducer Physical Model**

**Figure 3. Equivalent Circuit Model**

**SPECIAL FEATURES**

**Filtering**

The Motorola accelerometers contain an onboard 4-pole switched capacitor filter. A Bessel implementation is used because it provides a maximally flat delay response (linear phase) thus preserving pulse shape integrity. Because the filter is realized using switched capacitor techniques, there is no requirement for external passive components (resistors and capacitors) to set the cut-off frequency.

**Self-Test**

The sensor provides a self-test feature that allows the verification of the mechanical and electrical integrity of the accelerometer at any time before or after installation. This feature is critical in applications such as automotive airbag

systems where system integrity must be ensured over the life of the vehicle. A fourth “plate” is used in the g-cell as a self-test plate. When the user applies a logic high input to the self-test pin, a calibrated potential is applied across the self-test plate and the moveable plate. The resulting electrostatic force ( $F_e = 1/2 AV^2/d^2$ ) causes the center plate to deflect. The resultant deflection is measured by the accelerometer’s control ASIC and a proportional output voltage results. This procedure assures that both the mechanical (g-cell) and electronic sections of the accelerometer are functioning.

**Ratiometricity**

Ratiometricity simply means that the output offset voltage and sensitivity will scale linearly with applied supply voltage. That is, as you increase supply voltage the sensitivity and offset increase linearly; as supply voltage decreases, offset and sensitivity decrease linearly. This is a key feature when interfacing to a microcontroller or an A/D converter because it provides system level cancellation of supply induced errors in the analog to digital conversion process.

**Status**

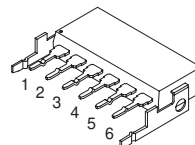
Motorola accelerometers include fault detection circuitry and a fault latch. The Status pin is an output from the fault latch, OR’d with self-test, and is set high whenever one (or more) of the following events occur:

- Supply voltage falls below the Low Voltage Detect (LVD) voltage threshold
- Clock oscillator falls below the clock monitor minimum frequency
- Parity of the EPROM bits becomes odd in number.

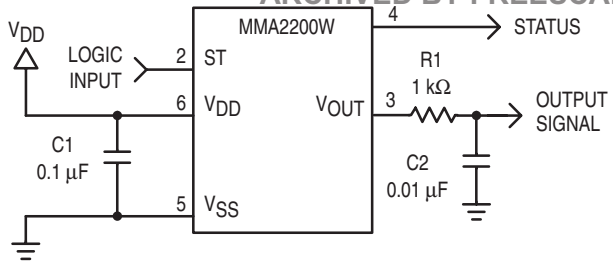
The fault latch can be reset by a rising edge on the self-test input pin, unless one (or more) of the fault conditions continues to exist.

**BASIC CONNECTIONS**

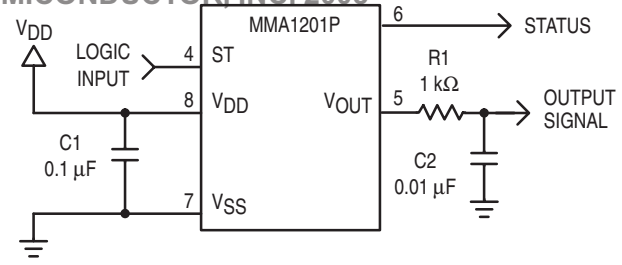
**Pinout Description for the Wingback Package**



Pin No.	Pin Name	Description
1	—	Leave unconnected or connect to signal ground
2	ST	Logic input pin to initiate self test
3	VOUT	Output voltage
4	Status	Logic output pin to indicate fault
5	VSS	Signal ground
6	VDD	Supply voltage (5 V)
—	Wings	Support pins, internally connected to lead frame. Tie to VSS.

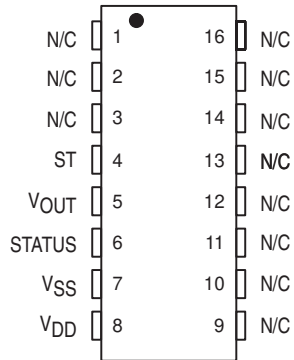


**Figure 4. Wingback Accelerometer with Recommended Connection Diagram**



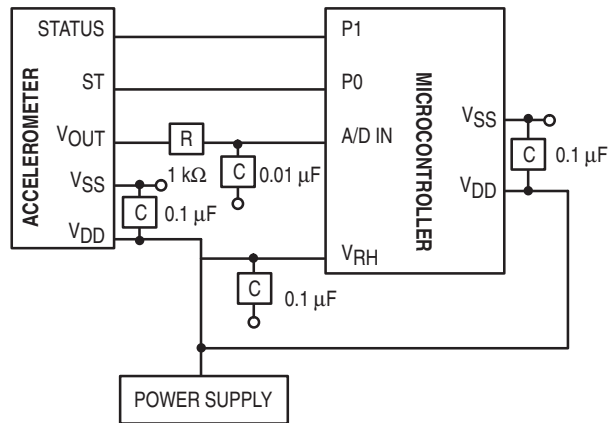
**Figure 5. DIP Accelerometer with Recommended Connection Diagram**

**Pinout Description for the DIP Package**



Pin No.	Pin Name	Description
1	—	Leave unconnected or connect to signal ground.
2 thru 3	—	No internal connection. Leave unconnected.
4	ST	Logic input pin to initiate self test.
5	VOUT	Output voltage
6	Status	Logic output pin to indicate fault.
7	VSS	Signal ground
8	VDD	Supply voltage (5 V)
9 thru 13	Trim Pins	Used for factory trim. Leave unconnected.
14 thru 16	—	No internal connection. Leave unconnected.

**PCB Layout**



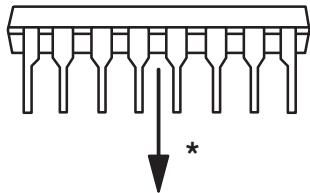
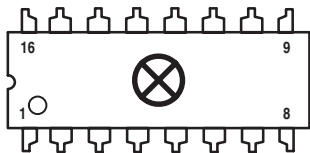
**Figure 6. Recommend PCB Layout for Interfacing Accelerometer to Microcontroller**

**NOTES:**

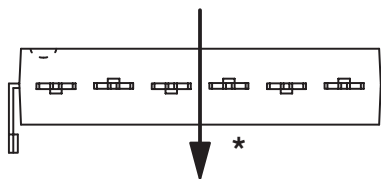
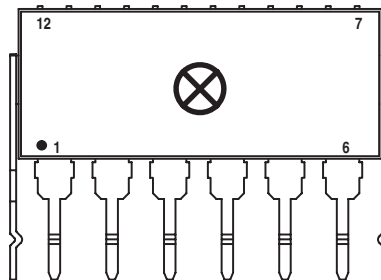
- Use a 0.1 μF capacitor on VDD to decouple the power source.
- Physical coupling distance of the accelerometer to the microcontroller should be minimal.
- Place a ground plane beneath the accelerometer to reduce noise, the ground plane should be attached to all of the open ended terminals shown in Figure 6.
- Use an RC filter of 1 kΩ and 0.01 μF on the output of the accelerometer to minimize clock noise (from the switched capacitor filter circuit).
- PCB layout of power and ground should not couple power supply noise.
- Accelerometer and microcontroller should not be a high current path.
- A/D sampling rate and any external power supply switching frequency should be selected such that they do not interfere with the internal accelerometer sampling frequency. This will prevent aliasing errors.

Positive Acceleration Sensing Direction

DIP PACKAGE



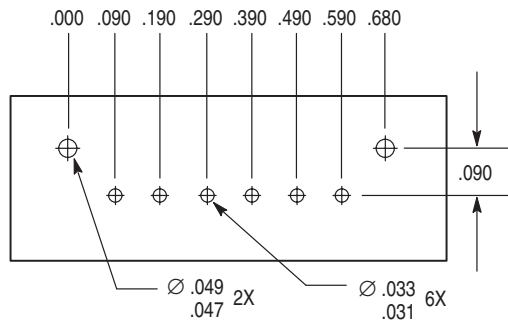
WINGBACK PACKAGE



\* When positioned as shown, the Earth's gravity will result in a positive 1g output

Drilling Patterns

WB PACKAGE DRILLING PATTERN



Measurement in inches

ORDERING INFORMATION

Device	Temperature Range	Case No.	Package
MMA1201P	-40 to +85°C	Case 648C-04	Plastic DIP
MMA2200W	-40 to +85°C	Case 456-06	Plastic Wingback

